

WAVELINE®

12'w x 4'h WL Hanging Sign

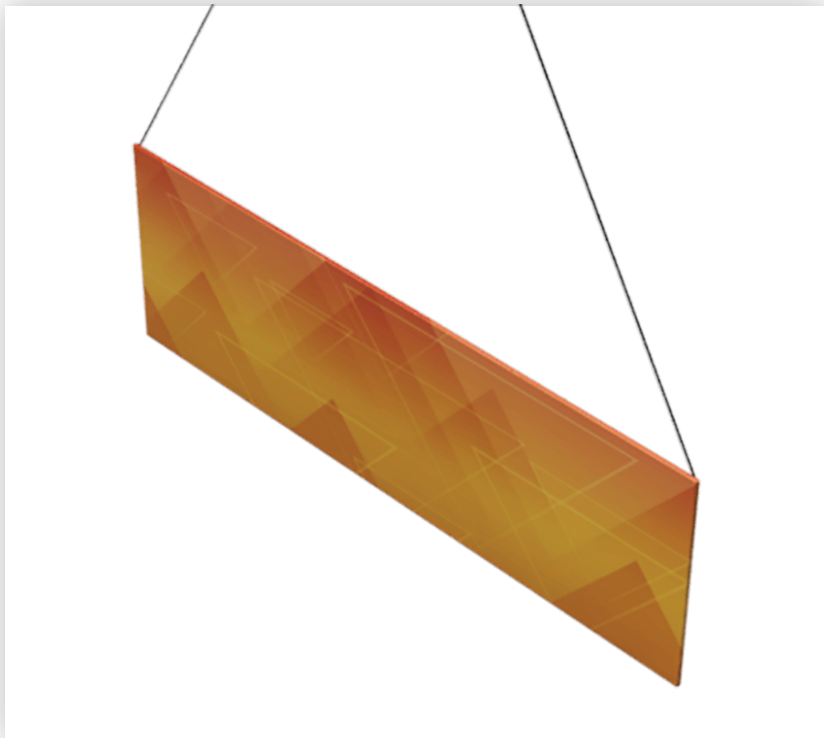
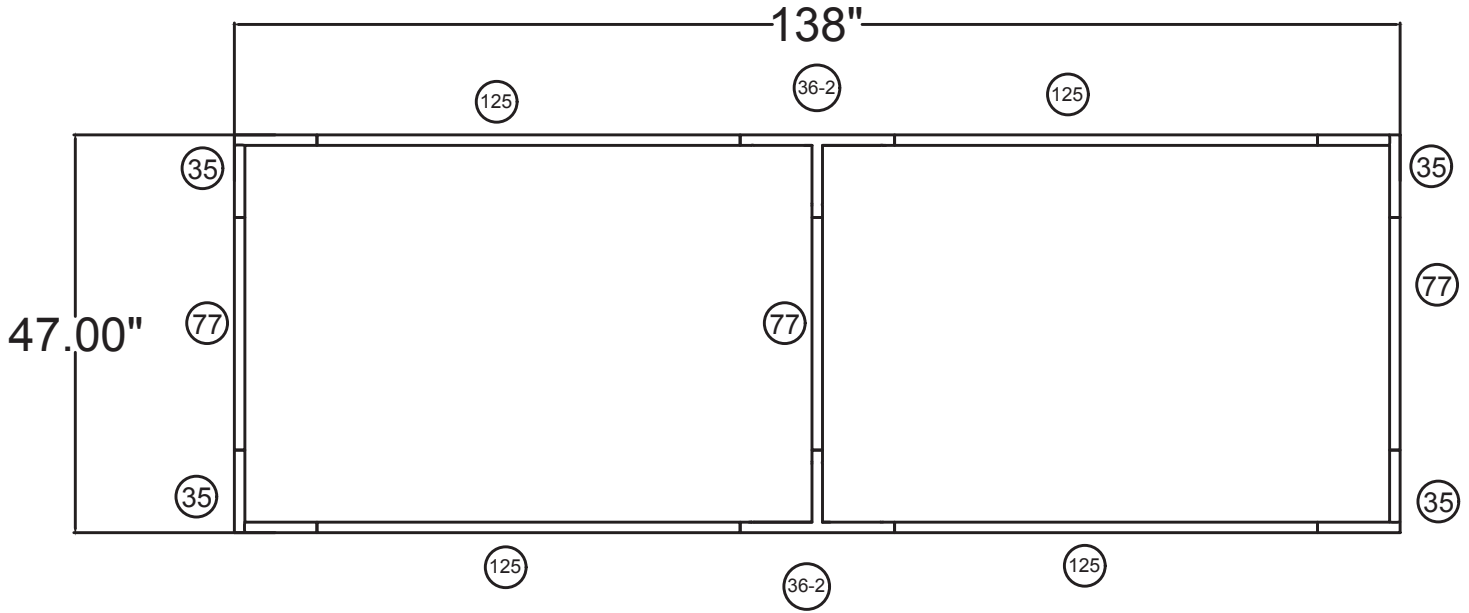

FHS1248

12'w x 4'h WL Hanging Sign	
Qty.	Part Number
4	WLM#035
3	WLM#077
4	WLM#125
2	WLM#036-2
1	BGO BAG-L

Notes:

- * Does not include Hanging Cables
- * will fit inside CA600 or CA900 case

WAVELINE®

Hanging Sign Rigging Instructions



Step 1

After assembling the sign, locate the hanging points. There are openings on the zipper to allow for cables to be inserted



Step 2

Open the zippers to expose the hanging area, then wrap the cables around the vertical support pole

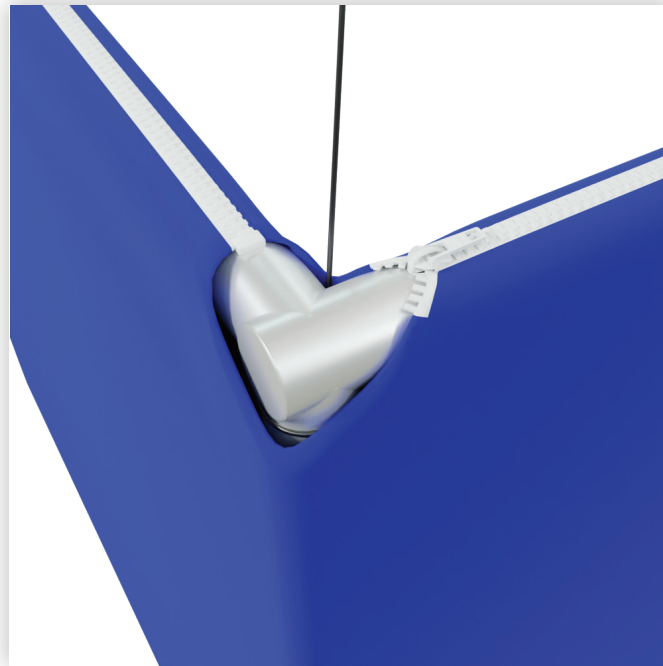

Step 3

Pull the cable through the opening in the fabric. Close the zippers.

*Hanging cables are not included in the kit, to be provided by on-site rigging team.