

WAVELINE®

10'w x 4'h WL Hanging Sign

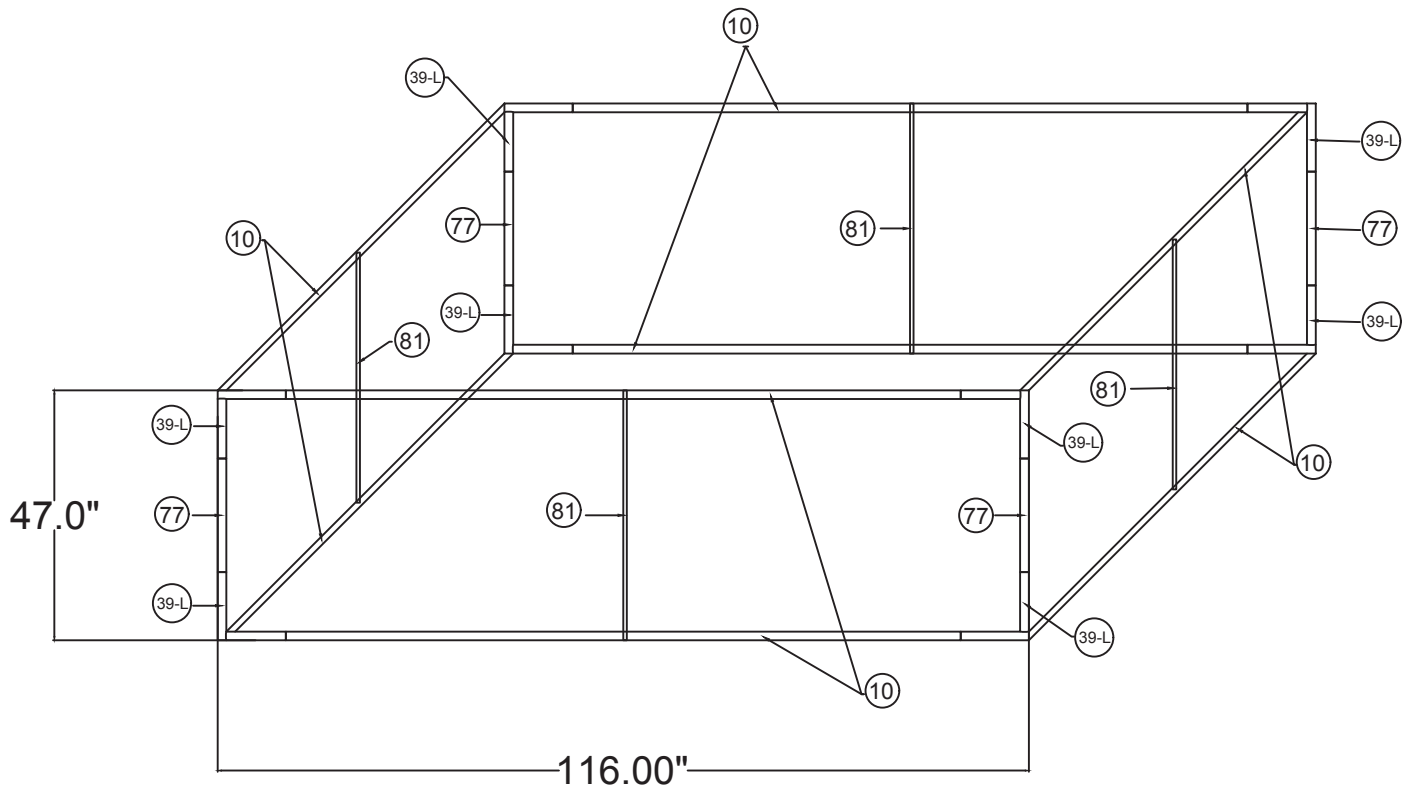

SHS1048

10'w x 4'h WL Hanging Sign

Qty.	Part Number
8	WLM#039L-US
4	WLM#077
4	WLM#081
8	WLM#010
1	BGO-FABRIC-L bag

Notes:

- * Does not include Hanging Cables
- * Will fit inside a CA600 or CA900 case

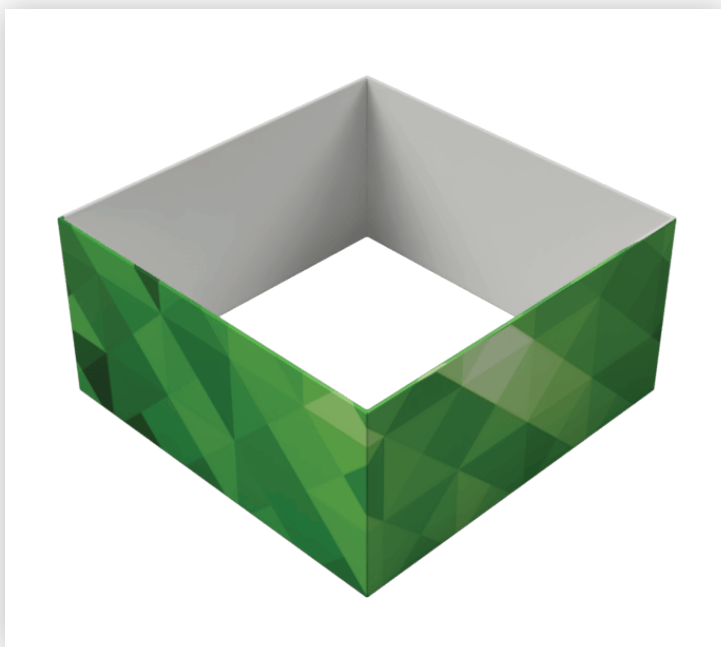

WAVELINE®

Hanging Sign Rigging Instructions



Step 1

After assembling the sign, locate the hanging points. There are openings on the zipper to allow for cables to be inserted



Step 2

Open the zippers to expose the hanging area, then wrap the cables around the vertical support pole

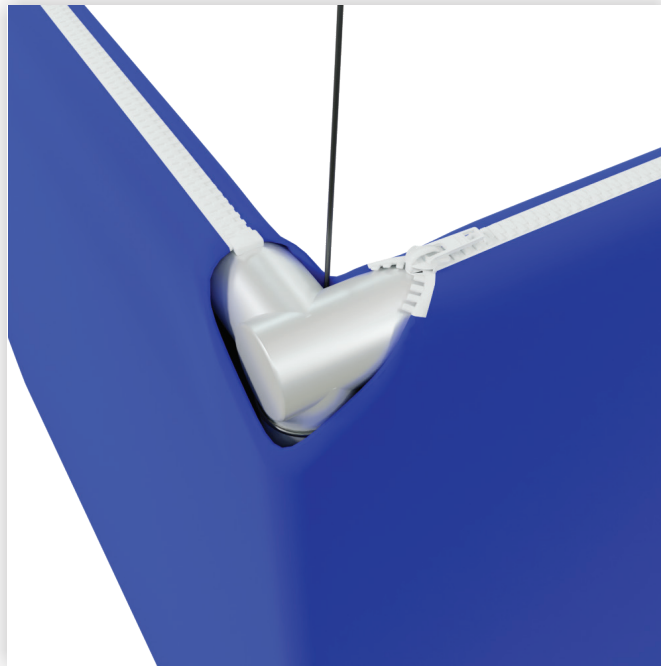

Step 3

Pull the cable through the opening in the fabric. Close the zippers.

*Hanging cables are not included in the kit, to be provided by on-site rigging team.