

WAVELINE®

12'w x 4'h WL Hanging Sign

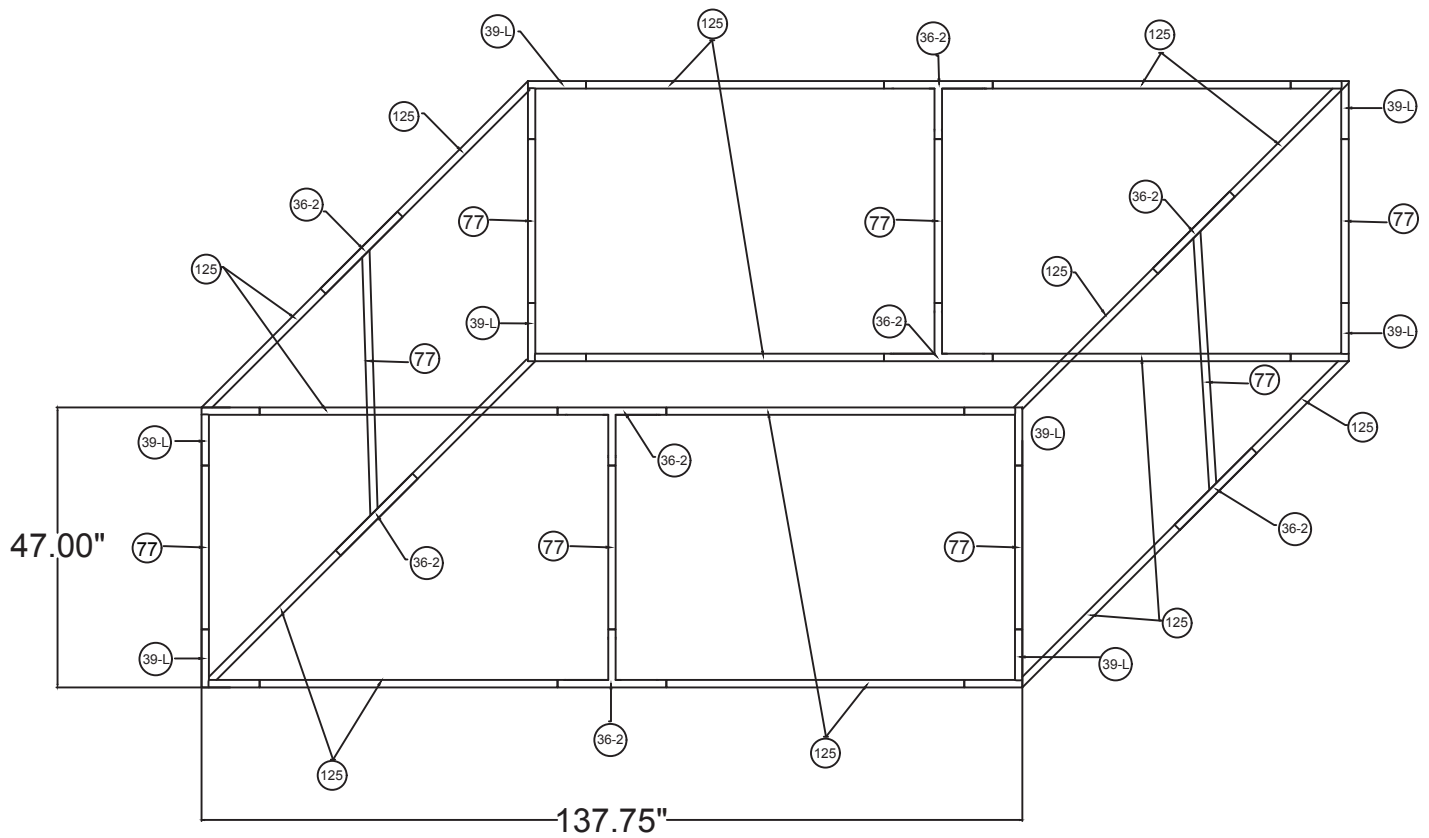

SHS1248

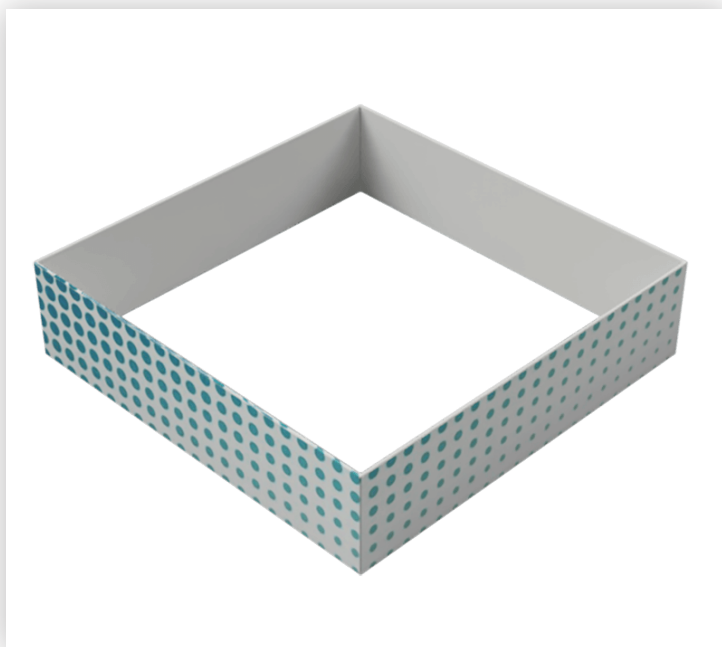

12'w x 4'h WL Hanging Sign	
Qty.	Part Number
8	WLM#039L-US
8	WLM#077
16	WLM#125
8	WLM#036-2-US
2	BGO-FABRIC-L bag

Notes:

- * Does not include Hanging Cables
- * Will fit inside a CA600 or CA900 case

