

Formulate Designer Series 10' Backwall - Kit 08

FMLT-DS-10-08

Formulate™ Designer Series 10ft displays have unique stylistic features and shapes, are portable and easy to assemble. The aluminum tube frame features snap-buttons and/ or spigot connections and zipper pillowcase fabric graphics. All displays come in portable, wheeled transit cases. Simply pull the pillowcase fabric graphic(s) over the frame and zip.



features and benefits:

- Premium aluminum tube frames with snap button / spigot assembly
- Easy to store and ship
- Quick to set up
- Weighted feet for added stability
- Two zipper pillowcase fabric graphics for walls and two zipper pillowcase graphics for canopy
- Kit includes: monitor kiosk featuring a medium monitor mount, can hold 32-55" monitor/ max weight 40lbs
- Lifetime limited hardware warranty against manufacturer defects

dimensions:

Hardware

Assembled unit:
114.59" w x 97.41" h x 37.09" d
2911mm(w) x 2474mm(h) x 942mm(d)

Approximate weight with cases:
196 lbs / 88.9 kgs

Shipping

Packing case(s):
3 OCE Cases

Shipping dimensions:
OCE: Expandable case length (l) may vary
40" - 66" l x 18" w x 18" h
1016mm-1677mm(l) x 458mm(w) x 458mm(h)

Approximate total shipping weight
(includes cases & graphics):
213 lbs / 96.6 kgs

Graphic

Refer to related graphic template for more information.

Visit:
www.exhibitors-handbook.com/graphic-templates

additional information:

Graphic material:
dye-sublimation zipper pillowcase fabric

We are continually improving and modifying our product range and reserve the right to vary the specifications without prior notice. All dimensions and weights quoted are approximate and we accept no responsibility for variance. E&OE. See Graphic Templates for graphic bleed specifications.

Included In Your Kit

Tools, Components, & Connectors



ALLEN KEY SET x1



ES50 x6



LN114-SCRW x2



TC-30-A-90 x2



TC-30-A x1



LN114-S2-450 x1



TC-30-90T x4



TC-30-90B x1

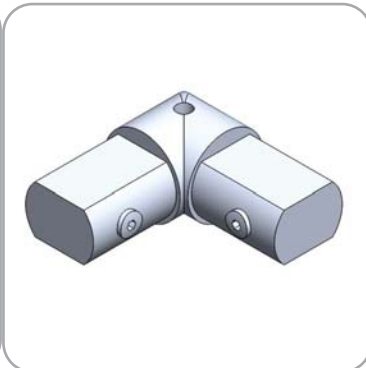

ES50-2W x1

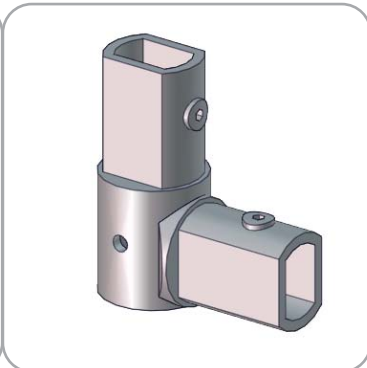

ES50-C ES50-I x1



LN114-S2-650 x1

Included In Your Kit

Graphics

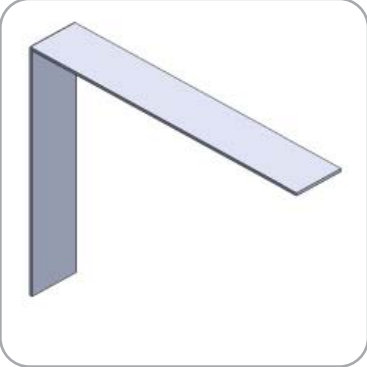

FMLT-DS-10-08-A-G x1

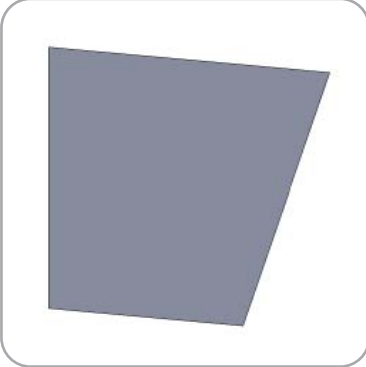

FMLT-DS-10-08-B-G x1

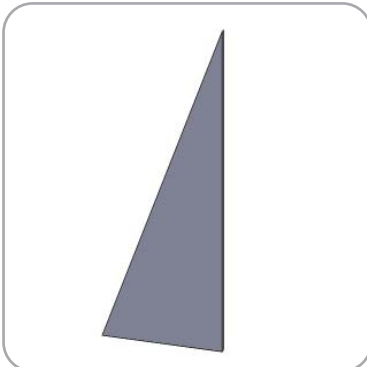

FMLT-DS-10-08-C-G x1

Included In Your Kit

Tubes



DS-10-08-A-T1 x6



DS-10-08-A-T2 x2



DS-10-08-A-T3 x2

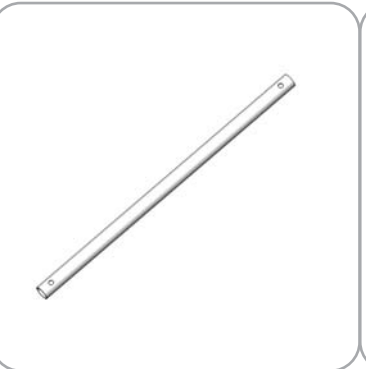

DS-10-08-A-T4 x3



DS-10-08-A-T5 x2

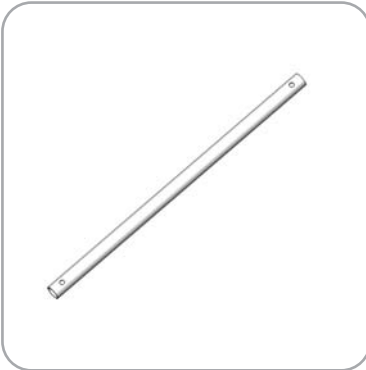

DS-10-08-A-T6 x2



DS-10-08-B-T1 x1

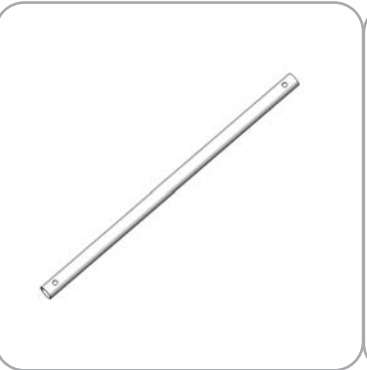

DS-10-08-B-T2 x3



DS-10-08-B-T3 x1



DS-10-08-B-T4 x3

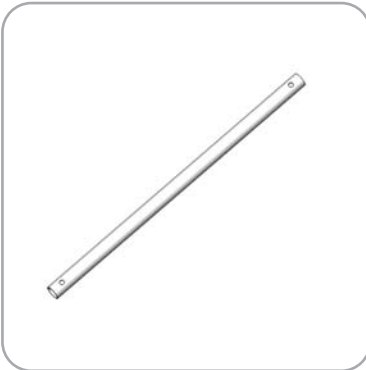

DS-10-08-C-T1 x1



DS-10-08-C-T2 x2



DS-10-08-C-T3 x1



DS-10-08-C-T4 x1



DS-10-08-C-T5 x1

Exploded View

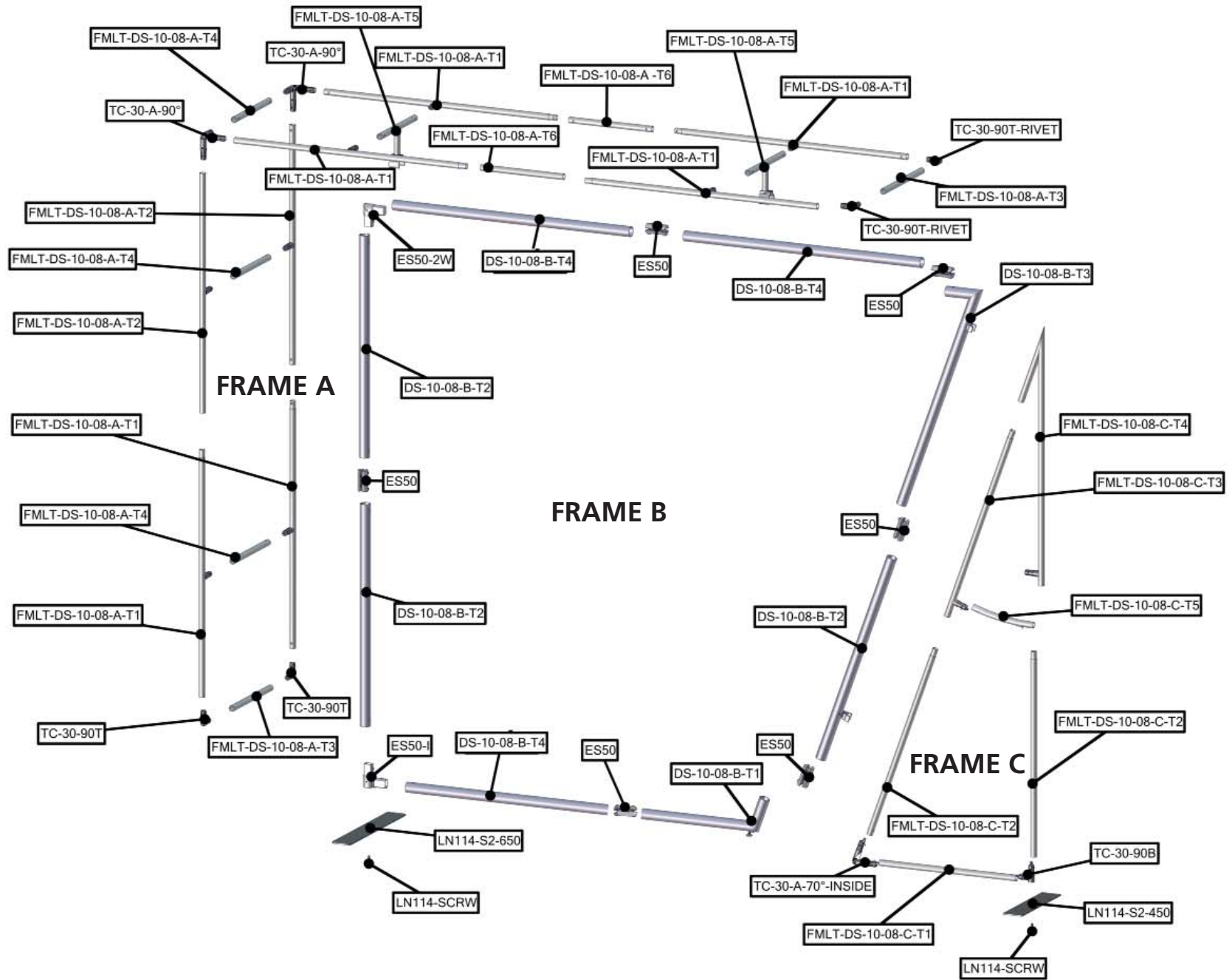

Labeling Diagram

FMLT-DS-10-08

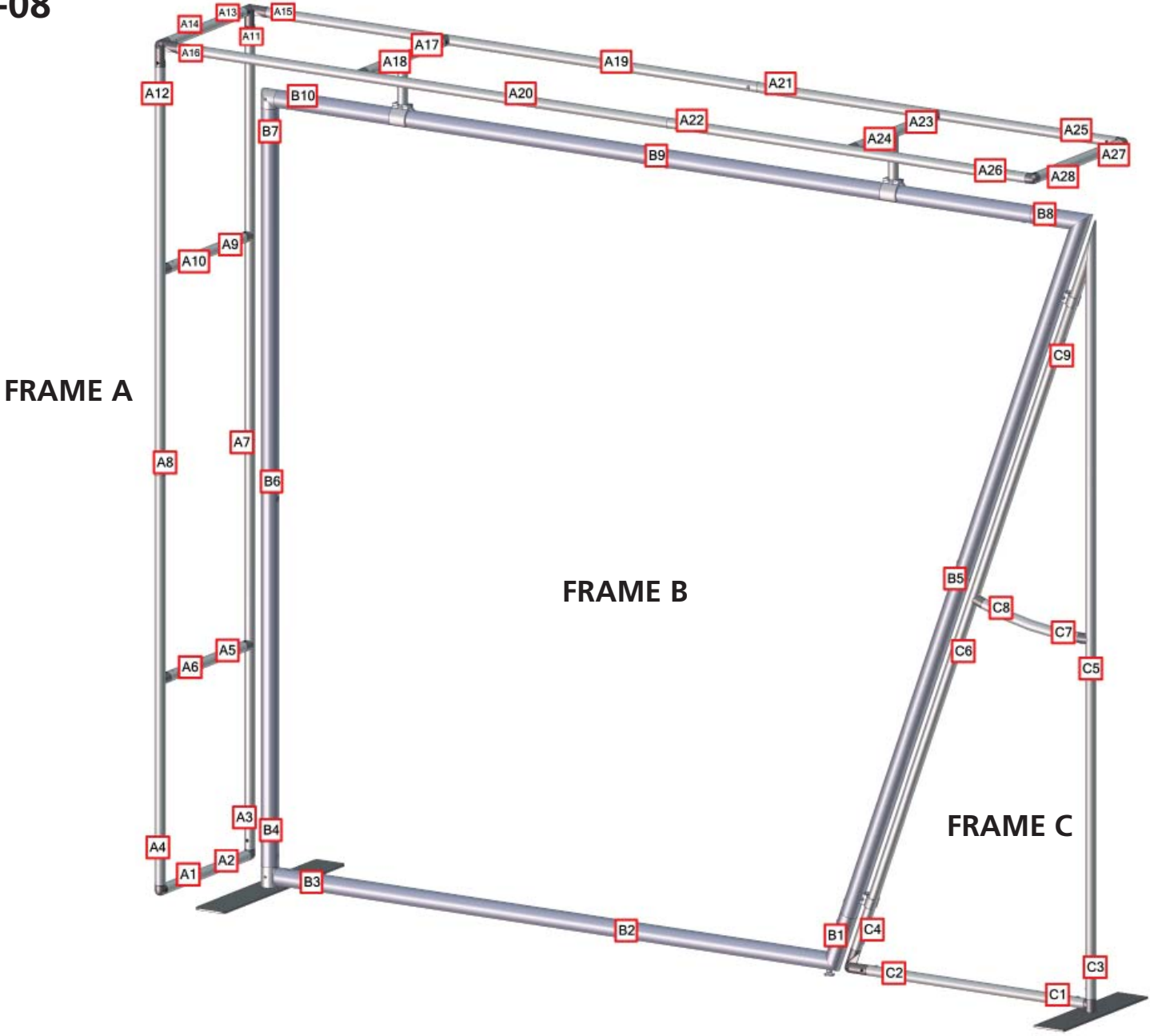

Connection Methods

Formulate™ structures use a number of different yet simple connection methods. Your kit will include one or more of the connection methods shown below. Steps within the Kit Assembly will reference a specific method for each connection point.

Connection Method 1: ES30 / ES50 / ES75

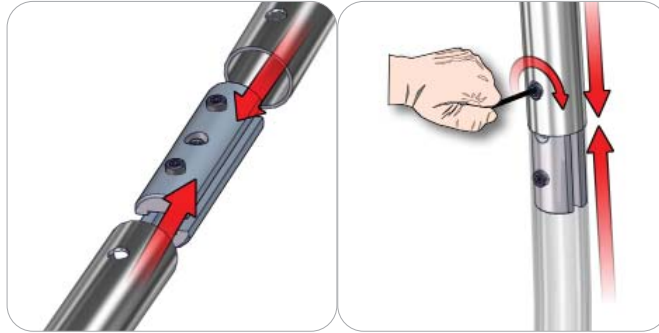

Compress the unlocked connector and slide one tube onto each end. Lock both screws carefully using your allen key tool. Be sure to lock securely, but do not overtighten.

Connection Method 2: Snap Buttons & Swage

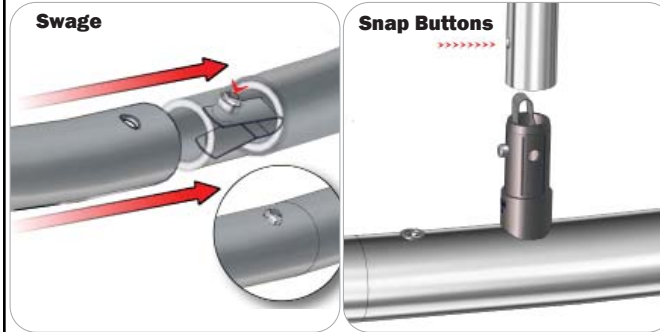

Locate the snap button on the connector or swage tube. Locate the hole on the corresponding tube. Press the snap button with your thumb and slide the tube and connector together so that the snap button snaps fully into the lock hole. To disassemble, press the snap button and pull apart.

Connection Method 3: ES30-90B / ES30-I / ES30-C



Compress one unlocked end of the connector and slide it through one tube end. Compress the other end of the connector and slide the second tube on. Lock both screws carefully using your allen key tool. Be sure to lock securely, but do not overtighten.

Connection Method 4: Tube Clamps

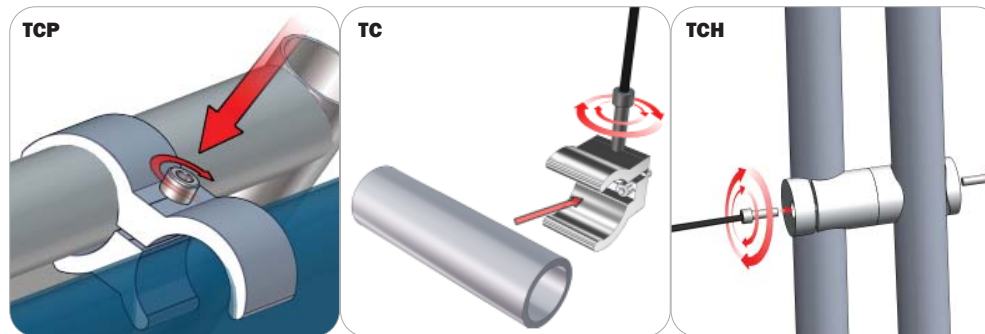

Be sure to fully assemble all frames before using clamps. With the clamp unlocked, place one tube of the first frame into the mouth of the clamp. Place the second tube (if applicable) into the second mouth of the clamp. With both frame's tubes in the clamp, be sure to lock securely, but do not overtighten.

Kit Assembly

Step by Step

Step 1.

Locate the components necessary for assembling Frame B. Assemble your frame in order according to the Labeling Diagram.

Please reference Connection Methods 1 and 3 for more details

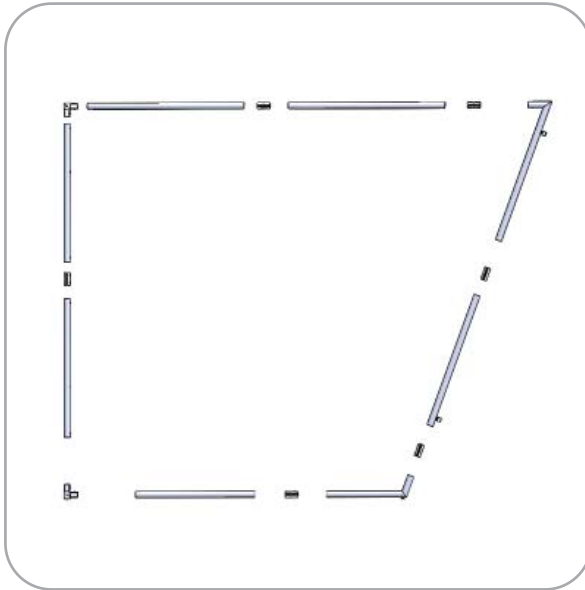
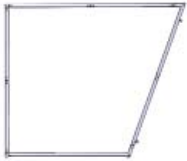

Step 2.

Fit Graphic B onto Frame B. For ease of installation, pull the fabric cover over the top left of the frame toward the bottom right while the frame rests flat on the floor. Zip to enclose.

Zipper located to the left side and bottom of Graphic B.



Step 3.

Gather a LN114-S2-650, and a LN114 screw. Attach the foot to the left (straight) side of Frame B.

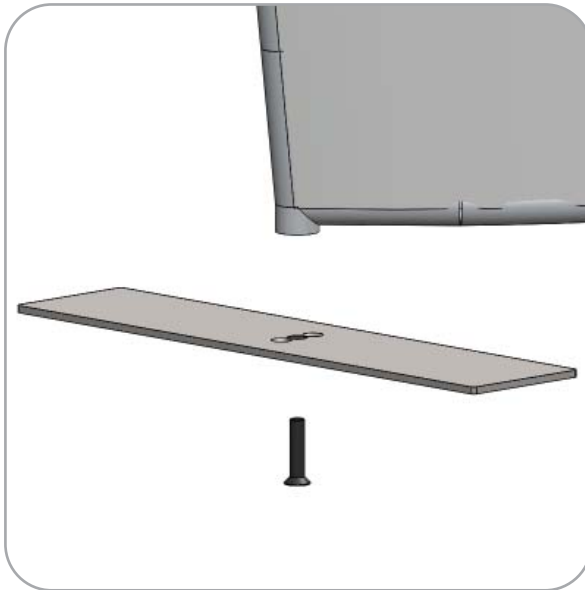
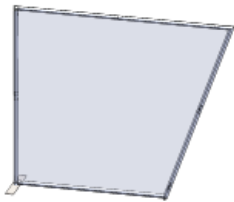

Step 4.

Locate the components necessary for assembling Frame C. Assemble your frame in order according to the Labeling Diagram.

Please reference Connection Methods 2 for more details

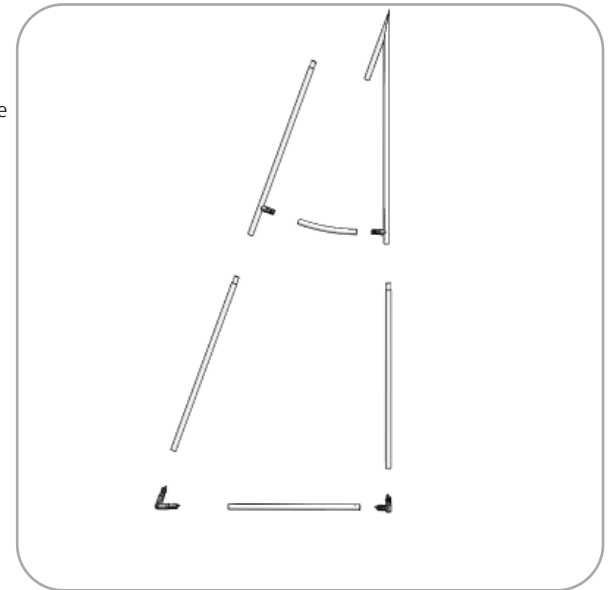

Kit Assembly

Step by Step

Step 5.

Fit Graphic C onto Frame C. For ease of installation, pull the fabric cover over the top of the frame while the frame rests flat on the floor. Zip to enclose.

Zipper located to the bottom of Graphic C

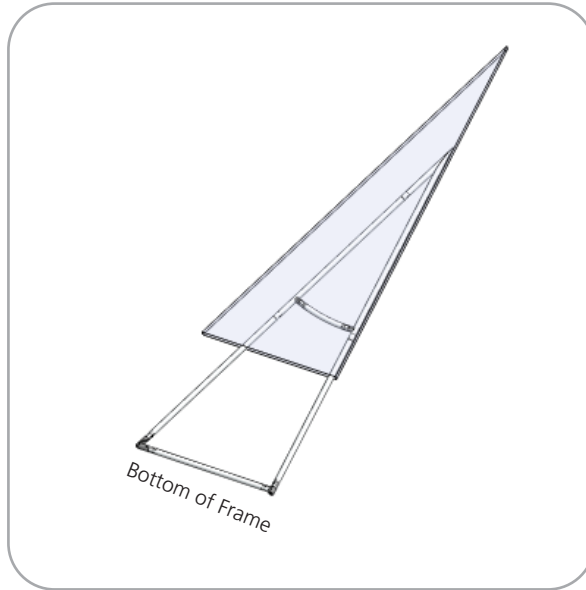

Step 6.

Gather a LN114-S2-450, and a LN114 screw. Attach the foot to the right (straight) side of Frame C.

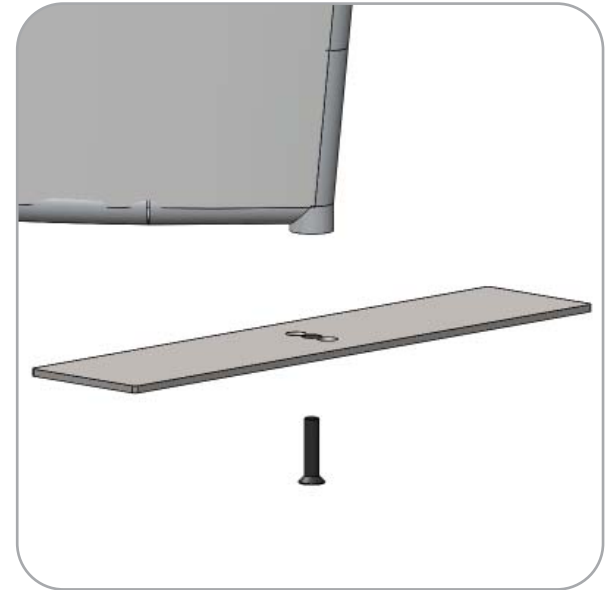
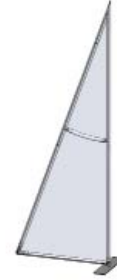

Step 8.

Locate the components necessary for assembling Frame A. Assemble your frame in order according to the Labeling Diagram.

Please reference Connection Methods 2 for more details

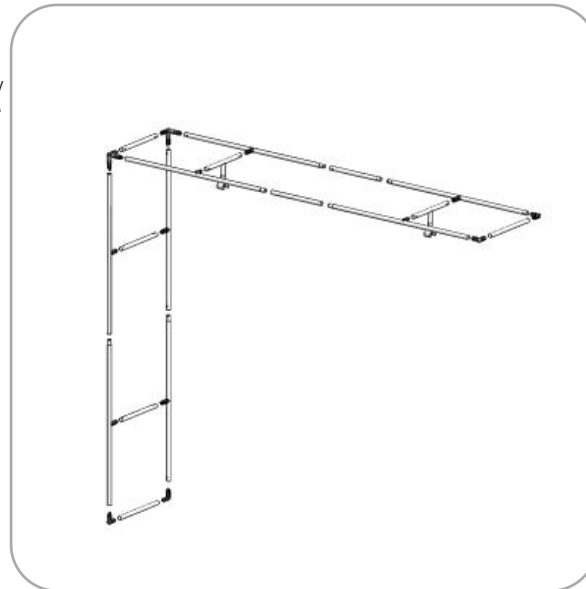
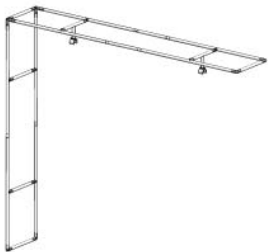

Step 7.

Fit Graphic A onto Frame A. For ease of installation, pull the fabric cover up from the bottom of the frame while the frame rests flat on the floor. Zip to enclose.

Zipper located to the back side of Graphic A

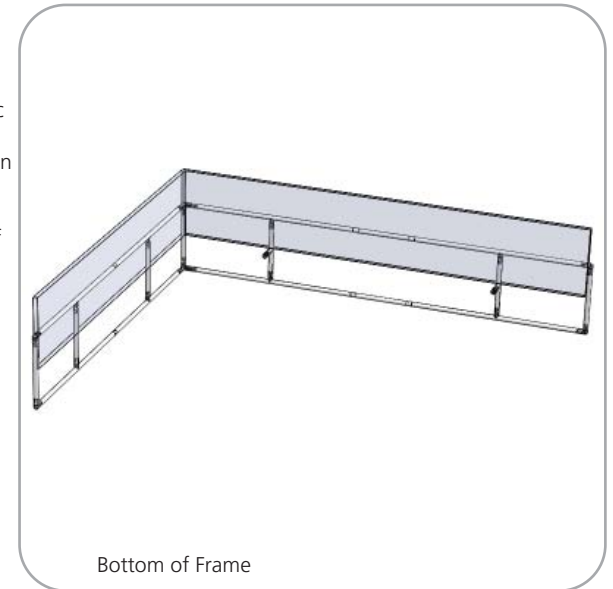

Kit Assembly

Step by Step

Step 9.

Assemble the kit by connecting each frame by there clamps. Tighten with your provided allen key tool.

Please reference Connection Methods 4 for more details

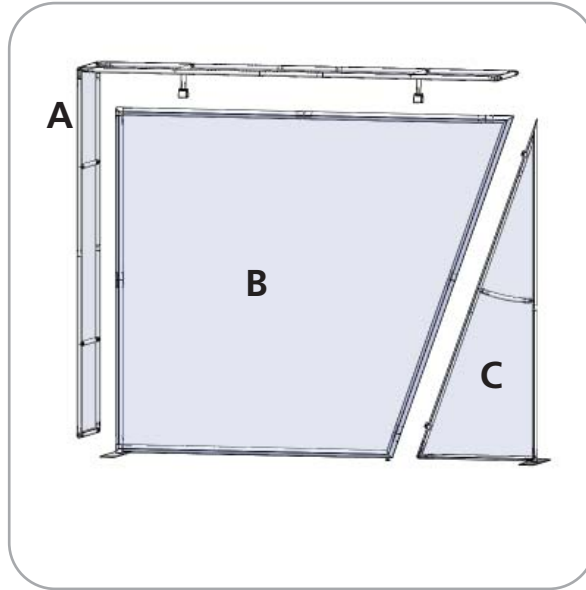
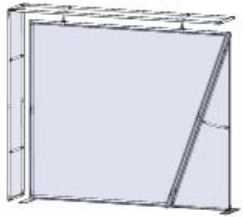

Step 10.

Place your monitor stand (*Reference the PM4S3-MK-M Kit here and related Instructions*) behind Frame B. Attach your monitor bracket to the stand through the front holes of the graphic.

